

SELECTING THE RIGHT BALL MOUNT & HITCH BALL

LENGTH

Distance from the center of the ball hole to the center of the pin hole

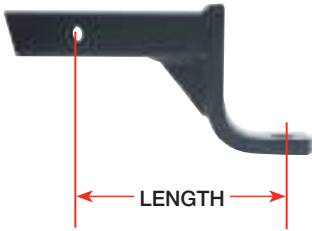

RISE

Distance from the top of the shank to the top of the ball platform



DROP

Distance from the top of the shank to the top of the ball platform



SELECTING THE RIGHT BALL MOUNT

Tow vehicle and trailer level



For safe, comfortable towing, the trailer should always be set up to tow on a level plane.

Trailer not level



Sometimes a trailer's tongue is higher or lower than the ball mount on the vehicle, and a ball mount with a "rise" or a "drop" is required to level the trailer.

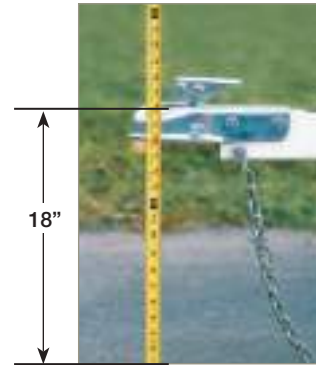
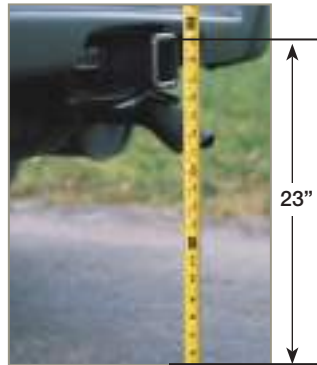

MEASURING FOR THE PROPER BALL MOUNT

1. Measure from the ground to the top of the hitch.
2. Measure from the ground to the (inside) top of the trailer coupler, when level.
3. Subtract the height of the hitch ball (most are 2-1/2" - 3" high) from coupler measurement.
4. An 8" drop is needed to make the trailer level.

THE DIFFERENCE IN THE TWO MEASUREMENTS IS THE AMOUNT OF BALL MOUNT "RISE" OR "DROP" REQUIRED.

SELECTING THE RIGHT HITCH BALL

Selecting the right hitch ball is a must for trouble-free towing.

Always use the properly rated hitch ball for your towing system.

- Your towing system's maximum weight rating is always equal to the lowest rated item in the system
- Your hitching system cannot be upgraded to a rating higher than the maximum rating of your hitch

For example, a 3,500 lbs. ball on a 2,000 lbs. max trailer weight-rated hitch does not increase your towing capacity to 3,500 lbs. Your hitching system is still rated at 2,000 lbs.

Conversely, a 2,000 lbs. ball on a 3,500 lbs. max trailer weight-rated hitch decreases your maximum towing capacity to 2,000 lbs.

The hitch ball diameter (A) must be the same diameter as the trailer coupler (1-7/8", 2", or 2-5/16").

The shank diameter (B) of the hitch ball should be the same as the hole diameter in the (correct) ball mount you selected.

The shank length (C) should be long enough to allow at least two threads to be visible when the hitch ball is installed and the nut completely tightened.

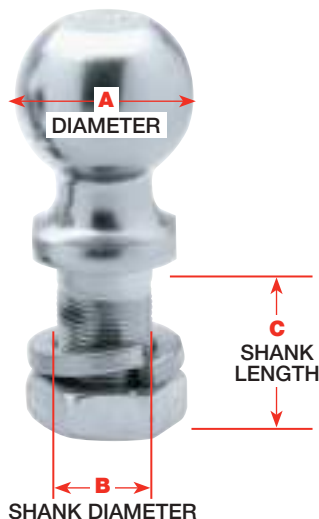

HITCH ACCESSORIES

HITCH BALLS

Interchangeable Hitch Ball System

Hitch Balls

BALL MOUNTS

Class I & II Drawbars

Ball Mounts

Solid Forged Ball Mounts

Aluminum Solid Forged Ball Mounts

Ultra Frame® Ball Mounts

Titan® Ball Mounts

Cushioned Ball Mounts

Towing Starter Kits

Adjustable Ball Mounts

Reversible Dual / Tri-Ball Mounts

Super Titan® Dual-Ball Mounts

Titan® Tri-Ball Mount

HITCH ACCESSORIES

Bumper Guard

Reducer Bushing

Receiver Adapters

Reducer Sleeves

Receiver Extensions

PINTLE HOOKS AND ACCESSORIES

Pintle Hooks / Mounts

Pintle Accessories

PINS / CLIPS / LOCKS / TUBE COVERS

Pins and Clips

Hitch / Trailer / Couplers Locks

Tube Covers





Designed to accommodate towing multiple trailers with ease, Tow Ready Interchangeable Hitch Ball System allows you to change hitch ball sizes in seconds without any tools. Available in 2 and 3-ball sets, these kits feature a quick-release, positive-latch design. Available in 3/4" and 1" shank models.



INTERCHANGEABLE HITCH BALL SETS

- Innovative quick release changes balls in seconds
- Rated capacities up to 8,000 lbs.
- Durable heat treated shank
- New positive latch design
- No special tools required

Part No.	Shank	Ball A	Ball B	Ball C	Max GTW (lbs.)
63801	3/4"	1-7/8"	2"	—	5,000
63802	1"	1-7/8"	2"	—	8,000
63804	1"	—	2"	2-5/16"	8,000
63803	1"	1-7/8"	2"	2-5/16"	8,000



STEP 1: ATTACH SHANK

- Attach correct shank to drawbar or ball mount
- Torque to required tightness



STEP 2: ATTACH BALL

- Select the correct ball size for your trailer
- Place ball on shank



STEP 3: TIGHTEN LOCKING HEAD

- Innovative locking screw requires only 1/4 turn to secure
- No need for special tools



YOU'RE TOW READY!



REPLACEMENT PARTS

Part No.	Description	Max GTW (lbs.)
63805	1-7/8" Interchangeable Hitch Ball Head	—
63806	2" Interchangeable Hitch Ball Head	—
63807*	2-5/16" Interchangeable Hitch Ball Head	—
63808	3/4" Interchangeable Hitch Ball Shank	5,000
63809	1" Interchangeable Hitch Ball Shank	8,000

* Only to be used with a 1" shank



All hitch balls built with wrench flats



63840



63880



63851



63810-006



028351

HITCH BALLS

- Solid steel hitch balls engineered to meet all safety requirements of VESC regulation V-5
- Cold forged for superior strength
- When installing hitch balls, torque all 3/4" shank dia. (B) balls to 160 ft. lbs., 1" shank dia. (B) balls to 250 ft. lbs., and 1-1/4" shank dia. (B) balls to 450 ft. lbs.

BULK HITCH BALLS

Ball Dia. A	Finish		Shank Dia. B	Shank Length C	Drawbar Thickness Range	GTW GVWR Rating
	Zinc	Chrome				
1-7/8"	63811	63810	3/4"	1-1/2"	3/8"-5/8"	2,000
1-7/8"	63813	63812	3/4"	2-3/8"	3/8"-1-3/8"	2,000
1-7/8"	-	63814	3/4"	3-3/8"	3/8"-2-1/8"	2,000
1-7/8"	63817	63816	1"	2-1/8"	3/8"-3/4"	2,000
1-7/8"	63819	63818	1"	3-3/8"	3/8"-2-1/8"	2,000
2"	63821	63820	3/4"	1-1/2"	3/8"-5/8"	3,500
2"	63823	63822	3/4"	2-3/8"	3/8"-1-3/8"	3,500
2"	-	63824	3/4"	3-3/8"	3/8"-2-1/8"	3,500
2"	63827	63826	1"	2-1/8"	3/8"-3/4"	6,000
2"	63829	63828	1"	3-3/8"	3/8"-2-1/8"	6,000
2"	63831	63830	1-1/4"	2-3/4"	3/8"-1"	8,000
2-5/16"	63833	63832	1"	2-1/8"	3/8"-3/4"	6,000
2-5/16"	63835	63834	1-1/4"	2-3/4"	3/8"-1"	12,000
2-5/16"	-	63836#	1-1/4"	2-3/4"	3/8"-1"	14,000
2-5/16"	-	63840#	1-1/4"	2-3/4"	3/8"-1"	20,000

Hitch ball requires use with like rated receiver & ball mount. Consult tow vehicle owners manual for maximum towing capacities.

PACKAGED HITCH BALLS

Ball Dia. A	Finish			Shank Dia. B	Shank Length C	Drawbar Thickness Range	GTW GVWR Rating
	Zinc	Chrome	Stainless Steel				
1-7/8"	63881	63880	-	3/4"	1-1/2"	3/8"-5/8"	2,000
1-7/8"	-	63882	-	3/4"	2-3/8"	3/8"-1-3/8"	2,000
1-7/8"	63885	63884	63851	1"	2-1/8"	3/8"-3/4"	2,000
2"	63888	63887	-	3/4"	1-1/2"	3/8"-5/8"	3,500
2"	-	63889	-	3/4"	2-3/8"	3/8"-1-3/8"	3,500
2"	63892	63891	63852	1"	2-1/8"	3/8"-3/4"	6,000
2"	-	63899	-	1-1/4"	2-3/4"	3/8"-1"	8,000
2-5/16"	63895	63894	63853	1"	2-1/8"	3/8"-3/4"	6,000
2-5/16"	63897	63896	-	1-1/4"	2-3/4"	3/8"-1"	12,000

PACKAGED HITCH BALLS (6 PACK RETAIL DISPLAY)

Ball Dia. A	Finish		Shank Dia. B	Shank Length C	Drawbar Thickness Range	GTW GVWR Rating
	Zinc	Chrome				
1-7/8"	63810-006		3/4"	1-1/2"	3/8"-5/8"	2,000
1-7/8"	63816-006		1"	2-1/8"	3/8"-3/4"	2,000
2"	63826-006		1"	2-1/8"	3/8"-3/4"	6,000
2-5/16"	63832-006		1"	2-1/8"	3/8"-3/4"	6,000

PRECISION MACHINED COUPLER BALLS

Coupler balls are precision machined from high-strength steel bars. Coupler balls are carefully shaped and are recommended for BULLDOG couplers.

- Ball diameters from 2" to 2-5/16"
- High-strength steel
- Standard configurations available for a wide variety of applications

Part No.	Rated Capacity	Description	Unit Wt. Lbs.
028375	3,000	2" with 3/4" shank	2.4
028351 ♦	5,000	2" with 1" shank	2.5
028352	7,000	2" with 1" shank (heat treated)	2.5
028400 ♦	12,500	2-5/16" with 1-1/4" shank	4

♦ DENOTES MOST POPULAR

CLASS I & II DRAWBARS

We offer ball mounts and drawbars in three separate styles: straight cut, angle cut and drop cut. Refer to the styles below to select the mount that best suits your needs.



DRAWBAR TYPES

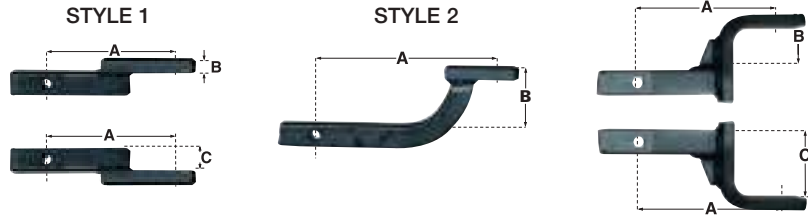

CLASS I DRAWBAR KITS

- Boxed includes drawbar, pin and clip
- Black powder coat finish over e-coat
- Fits 1-1/4" square receiver tube opening

Part No.	Rating (lbs.) GTW/TW	Ball Hole Size	A Length	B Rise	C Drop	Style
3590	2,000/200	3/4"	6-5/8"	5/8"	N/A	1
3591	2,000/200	3/4"	9-3/4"	5/8"	N/A	1
3592	2,000/200	3/4"	9-3/4"	2-1/8"	2-3/4"	3
3593	2,000/200	3/4"	6-5/8"	2-1/8"	2-3/4"	3
3594	2,000/200	3/4"	10"	4"	N/A	2

NOTE: Class I drawbar applications are specific. The correct replacement drawbar part number is listed on each Class I hitch installation instruction sheet.

CLASS II DRAWBAR KITS

- Boxed includes drawbar, pin and clip
- Black powder coat finish over e-coat
- Fits 1-1/4" square receiver tube opening

Part No.	Rating (lbs.) GTW/TW	Ball Hole Size	A Length	B Rise	C Drop	Style
36051	3,500/300	3/4"	7"	5/8"	1-1/4"	1
36053	3,500/300	3/4"	9-3/4"	5/8"	1-1/4"	1
36061	3,500/300	3/4"	9-3/4"	3-1/8"	N/A	2
36063	3,500/300	3/4"	11-3/4"	3-1/8"	N/A	2
36065	3,500/300	3/4"	10"	5"	N/A	2
36071	3,500/300	3/4"	7-3/16"	2-5/8"	3-1/4"	3
36078*	3,500/300	3/4"	7-3/8"	-	4-3/4"	3

* Fits 1-1/4" OEM Ford Explorer, Lincoln Aviator & Mercury Mountaineer hitch

NOTE: Class II drawbar applications are specific. The correct replacement drawbar part number is listed on each Class II hitch installation instruction sheet.

DRAWBAR OEM KITS

Part No.	Description
83637	Drawbar Kit for OEM Dodge Magnum hitch, 2,000 lbs. (includes pin and clip)

INVISI-HITCH™ ACCESSORIES

Part No.	Description
28451	Drawbar Kit, 2,000 lbs. (includes swivel pin)
28351	Accessory Adapter Kit (includes swivel pin)

SELECTING THE PROPER BALL MOUNT: BALL MOUNT MEASUREMENTS

LENGTH

Distance from the center of the ball hole to the center of the pin hole

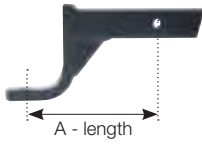

RISE

Distance from the top of the shank to the top of the ball platform



DROP

Distance from the top of the shank to the top of the ball platform

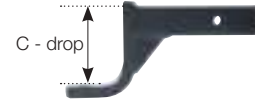

UP RATED

MAX FRAME MOUNT KITS – CLASS III/IV

- Fits 2" square receiver tube opening
- Includes pin and clip
- Black powder coat finish over e-coat

Part No.	Rating (lbs.) GTW/TW	Ball Hole Size	A Length	B Rise	C Drop	Style
2923	7,500/750	1"	8-1/2"	3/4"	2"	2
2953	6,000/600	1"	9"	2-3/4"	4"	2



**STYLE 2
ANGLE CUT**

UP RATED

EASY LOAD BALL MOUNTS

Featuring a revolutionary tapered shank design, easy-load ball mounts provide an easy connection to the receiver.

- Angle cut design
- Fits 2" square receiver tube opening
- Black powder coat finish over e-coat

Part No.	Bulk Part No.	Rating (lbs.) GTW/TW	Ball Hole Size	A Length	B Rise	C Drop	Style
40342	40342-006	7,500/750	1"	8-1/2"	3/4"	2"	2
40343	40343-006	6,000/600	1"	10-1/2"	3/4"	2"	2
40344	40344-006	6,000/600	1"	9"	2-3/4"	4"	2
40345	40345-006	6,000/600	1"	11"	2-3/4"	4"	2
40346	40346-002	6,000/600	1"	9-1/2"	4-3/4"	6"	2

Note: Pin and clip sold separately



**STYLE 3
DROP CUT**

UTILITY BALL MOUNTS

- Fits 2" square receiver tube opening
- Bulk boxed
- Black powder coat finish over e-coat

Part No.	Bulk Part No.	Rating (lbs.) GTW/TW	Ball Hole Size	A Length	B Rise	C Drop	Style
2736	2736-006	5,000/500	1"	12"	3/4"	2"	1
2793	2793-002	5,000/500	1"	10"	6-3/4"	8"	3
2706		3,500/350	1"	9"	9-3/4"	-	3
		5,000/500	1"	9"	-	11"	

Note: Pin and clip sold separately

PACKAGED ANGLED CUT BALL MOUNTS

- Fits 2" square receiver tube opening
- Includes pin and clip
- Black powder coat finish over e-coat



Part No.	Rating (lbs.) GTW/TW	Ball Hole Size	A Length	B Rise	C Drop	Style
40443	6,000/600	1"	10-1/2"	3/4"	2"	2
40446	6,000/600	1"	9-1/2"	4-3/4"	6"	2



PACKAGED CLASS III BALL MOUNTS

- Includes pin and clip
- Fits 2" square receiver tube opening



Part No.	Rating (lbs.) GTW/TW	Ball Hole Size	A Length	B Rise	C Drop	Style
80127	7,500/750	1"	8-1/2"	3/4"	2"	2
80139	6,000/600	1"	9"	2-3/4"	4"	2



STYLE 2

CLASS III BALL MOUNTS

- Black powder coat finish over e-coat
- Fits 2" square receiver tube opening



Part No.	Bulk Part No.	Rating (lbs.) GTW/TW	Ball Hole Size	A Length	B Rise	C Drop	Style
80227	80227-006	7,500/750	1"	8-1/2"	3/4"	2"	2
80226	80226-006	6,000/600	1"	10-1/2"	3/4"	2"	2
80232		6,000/600	1"	16"	3/4"	2"	2
80239*	80239-006*	6,000/600	1"	9"	2-3/4"	4"	2
80228	80228-006	6,000/600	1"	11"	2-3/4"	4"	2
80233		6,000/600	1"	16"	2-3/4"	4"	2
80240*		6,000/600	1"	9-1/2"	4-3/4"	6"	2
80213*	80213-002*	5,000/500	1"	10"	6-3/4"	8"	3
80248		5,000/500 3,500/350	1" 1"	9" 9"	- 9-3/4"	11" -	3



STYLE 3

* Not angle cut
Note: Pin and clip sold separately



QUICK-LOADING CLASS III BALL MOUNTS

Reese quick-loading ball mounts feature a revolutionary, angle-cut design. Provides a quick and easier connection to the receiver. All ball mounts meet or exceed SAE J684 and V-5 specifications.

- Fits 2" square receiver tube opening



Part No.	Bulk Part No.	Rating (lbs.) GTW/TW	Ball Hole Size	A Length	B Rise	C Drop	Style
21341*		5,000/500	1"	12"	3/4"	2"	1
21342	21342-006	7,500/750	1"	8-1/2"	3/4"	2"	2
21343	21343-006	6,000/600	1"	10-1/2"	3/4"	2"	2
21344	21344-006	6,000/600	1"	9"	2-3/4"	4"	2
21345	21345-006	6,000/600	1"	11"	2-3/4"	4"	2
21346	21346-002	6,000/600	1"	9-1/2"	4-3/4"	6"	2
21347*		5,000/500	1"	10"	6-3/4"	8"	3
21348*		5,000/500 3,500/350	1" 1"	9" 9"	- 9-3/4"	11" -	3



21343

21346

* Not angle cut
Note: Pin and clip sold separately



HITCH & TRAILER ALIGNMENT TOOL

- Convenient one person hitch alignment system
- Magnetic base for fast and easy location
- Telescoping rods adjust up to 42"
- Easy to use the first time



Part No.	Description
63300	Hitch & Trailer Alignment Tool



UP RATED ▶ SOLID FORGED BALL MOUNTS

- Solid one-piece forged construction
- 1" thick x 3" wide ball platforms
- Angled, easy-load design
- Black powder coat finish over e-coat
- Fits 2" square receiver tube opening



Part No.	Rating (lbs.) GTW/TW	Ball Hole Size	A Length	B Rise	C Drop
40330	16,000/2,400	1-1/4"	8-1/2"	1"	2"
40330-002 (2 pack)	16,000/2,400	1-1/4"	8-1/2"	1"	2"
40331	16,000/2,400	1-1/4"	9-1/4"	3"	4"
40331-002 (2 pack)	16,000/2,400	1-1/4"	9-1/4"	3"	4"
40332	16,000/2,400	1-1/4"	10-1/4"	5"	6"
40332-002 (2 pack)	16,000/2,400	1-1/4"	10-1/4"	5"	6"



Part No.	Rating (lbs.) GTW/TW	Ball Hole Size	A Length	B Rise	C Drop
80142	16,000/2,400	1-1/4"	8-1/2"	1"	2"
80143	16,000/2,400	1-1/4"	9-1/4"	3"	4"
80144	16,000/2,400	1-1/4"	10-1/4"	5"	6"



Part No.	Rating (lbs.) GTW/TW	Ball Hole Size	A Length	B Rise	C Drop
21330	16,000/2,400	1-1/4"	8-1/2"	1"	2"
21331	16,000/2,400	1-1/4"	9-1/4"	3"	4"
21332	16,000/2,400	1-1/4"	10-1/4"	5"	6"

ALUMINUM SOLID FORGED BALL MOUNTS

- Solid one-piece forged construction
- 1" thick x 3" wide ball platforms
- Aluminum finish
- Fits 2" square receiver tube opening



Part No.	Rating (lbs.) GTW/TW	Ball Hole Size	A Length	B Rise	C Drop
40381	8,000/800	1"	9-7/8"	1"	2"
40382	8,000/800	1"	10-5/8"	3"	4"
40383	8,000/800	1"	11-7/8"	5"	6"
40384	6,000/600	1"	10-7/8"	7"	8"



Part No.	Rating (lbs.) GTW/TW	Ball Hole Size	A Length	B Rise	C Drop
21381	8,000/800	1"	9-7/8"	1"	2"
21382	8,000/800	1"	10-5/8"	3"	4"
21383	8,000/800	1"	11-7/8"	5"	6"
21384	6,000/600	1"	10-7/8"	7"	8"



ULTRA FRAME® HOLLOW SHANK BALL MOUNTS

- Black powder coat finish over e-coat
- Fits 2" square receiver tube opening



Part No.	Rating (lbs.) GTW/TW	Ball Hole Size	A Length	B Rise	C Drop	Style
40200	10,000/1,000	1-1/4"	8-1/2"	3/4"	2"	1
40201	10,000/1,000	1-1/4"	9"	2-3/4"	4"	3
40202	10,000/1,000	1-1/4"	11-1/4"	2-3/4"	4"	3
40205	10,000/1,000	1-1/4"	9"	-	6"	3
40206	10,000/1,000	1-1/4"	9"	-	8"	3



Part No.	Rating (lbs.) GTW/TW	Ball Hole Size	A Length	B Rise	C Drop	Style
80132	10,000/1,000	1-1/4"	8-1/2"	3/4"	2"	1
80133	10,000/1,000	1-1/4"	9"	2-3/4"	4"	3
80136	10,000/1,000	1-1/4"	11-1/4"	2-3/4"	4"	3
80137	10,000/1,000	1-1/4"	9"	-	6"	3
80138	10,000/1,000	1-1/4"	9"	-	8"	3

ULTRA FRAME® SOLID SHANK BALL MOUNTS

- Fits 2" square receiver tube opening
- Durable zinc coated finish



Part No.	Rating (lbs.) GTW/TW	Ball Hole Size	A Length	B Rise	C Drop	Style
4280	12,000/1,200	1-1/4"	8-1/2"	1"	2"	1
4284	12,000/1,200	1-1/4"	12"	1"	2"	1
4281	12,000/1,200	1-1/4"	8-1/2"	3"	4"	3
4285	12,000/1,200	1-1/4"	12"	3"	4"	3
4282	12,000/1,200	1-1/4"	9-1/2"	5"	6"	3
4283	12,000/1,200	1-1/4"	9-1/2"	7"	8"	3



Part No.	Rating (lbs.) GTW/TW	Ball Hole Size	A Length	B Rise	C Drop	Style
80122	12,000/1,200	1-1/4"	8-1/2"	1"	2"	1
80123	12,000/1,200	1-1/4"	8-1/2"	3"	4"	3
80126	12,000/1,200	1-1/4"	12"	3"	4"	3
80124	12,000/1,200	1-1/4"	9-1/2"	5"	6"	3
80125	12,000/1,200	1-1/4"	9-1/2"	7"	8"	3

TITAN® BALL MOUNTS

- Fits 2-1/2" square receiver tube opening, for use exclusively with Titan® receivers
- Black powder coat finish over e-coat



Part No.	Rating (lbs.) GTW/TW	Ball Hole Size	A Length	B Rise	C Drop	Style
45122	14,000/1,400	1-1/4"	9-3/4"	1-1/2"	3"	3
45123	13,000/1,300	1-1/4"	10"	3-1/2"	5"	3
45291	13,000/1,300	1-1/4"	10-1/2"	-	7-3/4"	3
45322	18,000/2,000	1-1/4"	10"	1-1/2"	3"	3
45323	18,000/2,000	1-1/4"	10"	3-1/2"	5"	3



CUSHIONED BALL MOUNTS



These ball mounts feature two heavy-duty polyurethane cushions in the rear retainer to reduce the “slams” and “bangs” associated with trailer towing during starting, stopping and rough highways. Reducing these jolts helps to protect your towing vehicle’s driveline, hitch assembly and trailer contents. Cushioned ball mounts act as a shock absorber and fits 2” square receiver tube opening.

Part No.	Rating (lbs.) GTW/TW	Ball Hole Size	A Length	B Rise	C Drop
80420	10,000/1,000	1”	9-3/8”	3/4”	2”
80421	10,000/1,000	1”	9-7/8”	2-3/4”	4”
80422	10,000/1,000	1”	10-5/8”	4-3/4”	6”



CLASS III INTERLOCK TOWING STARTER KITS

- Includes 2” hitch ball
- Includes receiver lock
- Black powder coat finish over e-coat
- Fits 2” square receiver tube opening



Part No.	Rating (lbs.) GTW/TW	A Length	B Rise	C Drop	Secure
40565	6,000/600	8-1/2”	3/4”	2”	Lock



Part No.	Rating (lbs.) GTW/TW	A Length	B Rise	C Drop	Secure
80565	6,000/600	8-1/2”	3/4”	2”	Lock



Part No.	Rating (lbs.) GTW/TW	A Length	B Rise	C Drop	Secure
83565	6,000/600	8-1/2”	3/4”	2”	Lock



CLASS III STANDARD TOWING STARTER KITS (2-PACK)

- Point of purchase retail display
- Two kits per display box
- Fits 2” square receiver tube opening
- Includes pin and clip
- Black powder coat finish over e-coat (except 40567-002 w/Chrome Ball Mount)



Part No.	Rating (lbs.) GTW/TW	A Length	B Drop	C Ball Size	Secure
40563-002	6,000/600	8-1/2”	2”	2”	Pin/Clip
40567-002	6,000/600	8-1/2”	2”	2”	Pin/Clip
40566-002	6,000/600	9”	4”	2”	Pin/Clip



Part No.	Rating (lbs.) GTW/TW	A Length	B Drop	C Ball Size	Secure
80563-002	6,000/600	8-1/2”	2”	2”	Pin/Clip
80570-002	6,000/600	9”	4”	2”	Pin/Clip



Part No.	Rating (lbs.) GTW/TW	A Length	B Drop	C Ball Size	Secure
83563-002	6,000/600	8-1/2”	2”	2”	Pin/Clip
83570-002	6,000/600	9”	4”	2”	Pin/Clip

ADJUSTABLE BALL MOUNTS

Adjustable ball mounts are perfect for those who tow multiple trailers of varying coupler heights.

- Fits 2" square receiver tube opening, shank can be used in rise or drop position



6580

HOLLOW SHANK BALL MOUNT

- Rated at 6,000 lbs. GTW/600 lbs. TW
- Quick release pin and clip for maximum adjustability
- Black powder coat finish over e-coat



Part No.	Description	Length	Max. Rise	Max. Drop
6580	Complete Shank and Head Assembly with quick release pin and clip	12"	6-1/8"	7-3/8"



1420
1422
1424

SOLID SHANK BALL MOUNTS

- Rated at 5,000 lbs. GTW/500 lbs. TW
- Black powder coat finish over e-coat



Part No.	Description	Length	Max. Rise	Max. Drop
1420	Complete Shank and Head Assembly	12"	6"	7-1/4"
1422	Complete Shank and Head Assembly	14"	6"	7-1/4"
1424	Complete Shank and Head Assembly	16"	6"	7-1/4"

NOTE: Hitch ball, pin (55010) and clip (55515) sold separately. Not interchangeable with weight distribution replacement parts.



7390

HOLLOW SHANK BALL MOUNT WITH SWAY CONTROL TAB

- Rated at 6,000 lbs. GTW/600 lbs. TW
- Platform mounts for left or right hand sway control



Part No.	Description	Length	Max. Rise	Max. Drop
7390	Complete Shank and Head Assembly	12"	3-3/4"	5-1/4"

NOTE: Hitch ball, pin (55010) and clip (55515) sold separately. Not interchangeable with weight distribution replacement parts.



80412
80414

HOLLOW SHANK BALL MOUNTS

- Rated at 6,000 lbs. GTW/600 lbs. TW
- Quick release pin and clip for maximum adjustability



Part No.	Description	Length	Max. Rise	Max. Drop
80412	Adjustable Ball Mount, display pkg	12"	8-3/8"	9-5/8"
80414	Adjustable Ball Mount, bulk	14"	8-3/8"	9-5/8"
80417	Shank only (12" Length)			
80418	Ball Mount Plate only			



21141

BALL MOUNT

- Adjustable utility draw features 5,000 lbs. GTW/500 lbs. TW rating and 13-3/4" height adjustment capacity
- Quick release pin and clip for maximum adjustability



Part No.	Description	Length	Max. Rise	Max. Drop
21141	Adjustable Ball Mount	13-12"	6-1/4"	7-1/2"



7627

6352

HITCH BALL & BALL MOUNT BAGS

- Conveniently stores interchangeable and removable hitch balls when not in use
- Durable nylon with hook & loop closure to secure ball and keep vehicle clean

Part No.	Description
7627	Ball Mount Bag (ball mount not included)
6352	Hitch Ball Bag (hitch ball not included)

REVERSIBLE BALL MOUNTS

Reversible ball mounts are perfect for those who tow multiple trailer with varying ball diameters. Weight rating as per ball being used.



38180

SUPER TITAN® DUAL-BALL MOUNT

- Fits 3" square receiver tube opening, designed for Super Titan® Receivers
- Includes 2" (17,000 lbs.) & 2-5/16" (25,000 lbs.) hitch balls
- 9" Length



Part No.	Description
38180	Super Titan® Dual-Ball Mount (2" & 2-5/16")



45325

TITAN® TRI-BALL HOLLOW SHANK

- Fits 2-1/2" square receiver tube opening, designed for Titan® Receivers



Part No.	Description	Rating (lbs.) GTW/TW	Shank Length	Ball Size
45325	Titan® Tri-Ball Mount, Black Balls	2,000/200	8-3/4"	1-7/8"
		10,000/1,000	8-3/4"	2"
		14,000/1,400	7-1/2"	2-5/16"

DUAL-BALL / TRI-BALL SOLID SHANK

- Fits 2" square receiver tube opening



80795
80796

80797
80798

80791

80799

Part No.	Description	Rating (lbs.) GTW/TW	Shank Length	Ball Size
80795	Dual-Ball Mount, Black Balls, Black Solid Shank	2,000/200	8"	1-7/8"
		10,000/1,000	8"	2"
80796	Dual-Ball Mount, Black Balls, Black Solid Shank	10,000/1,000	8"	2"
		16,000/1,600	8"	2-5/16"
80797	Dual-Ball Mount, Chrome Balls, Black Solid Shank	2,000/200	8"	1-7/8"
		10,000/1,000	8"	2"
80798	Dual-Ball Mount, Chrome Balls, Black Solid Shank	10,000/1,000	8"	2"
		16,000/1,600	8"	2-5/16"
80791	Tri-Ball Mount, Black Balls, Black Solid Shank	2,000/200	8"	1-7/8"
		10,000/1,000	8"	2"
		16,000/1,600	6-3/4"	2-5/16"
80799	Tri-Ball Mount, Chrome Balls, Black Solid Shank	2,000/200	8"	1-7/8"
		10,000/1,000	8"	2"
		16,000/1,600	6-3/4"	2-5/16"

DUAL-BALL HOLLOW SHANK

- Fits 2" square receiver tube opening



80404
80405
80406

Part No.	Description	Rating (lbs.) GTW/TW	Ball Size	Position
80404	Dual-Ball Mount, Black Hollow Shank	2,000/200	1-7/8"	Rise
		6,000/600	2"	Drop
80405	Dual-Ball Mount, Black Hollow Shank	2,000/200	1-7/8"	Drop
		6,000/600	2"	Rise
80406	Dual-Ball Mount, Black Hollow Shank	6,000/600	2"	Drop
		6,000/600	2-5/16"	Rise

TRI-BALL HOLLOW SHANK

- Fits 2" square receiver tube opening



80425

80426

Part No.	Description	Rating (lbs.) GTW/TW	Shank Length	Ball Size
80425	Tri-Ball Mount, Black Balls, Black Hollow Shank	2,000/200	8"	1-7/8"
		6,000/600	8"	2"
		10,000/1,000	6-3/4"	2-5/16"
80426	Tri-Ball Mount, Chrome Balls, Black Hollow Shank	2,000/200	8"	1-7/8"
		6,000/600	8"	2"
		10,000/1,000	6-3/4"	2-5/16"



BUMPER GUARD, "THE HITCH GUIDE-AND-STOP"

- Protects vehicle from coupler impact while backing up
- Mounts to any ball mount with 1" hole



Part No.	Description
80400	Bumper Guard, black
80470	Bumper Guard, diamond plate



HITCH BALL WRENCH



Part No.	Description
74342	Hitch Ball Wrench, boxed end 1-1/8" & 1-1/2"

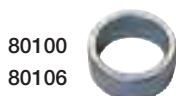

REDUCER BUSHING

- Allows 3/4" shank hitch balls to be used in ball mounts with 1" hole
- Allows 1" shank hitch balls to be used in ball mounts with 1-1/4" hole

Part No.	Description
80100	Reducer Bushing, 1" OD to 3/4" ID
80106	Reducer Bushing, 1-1/4" OD to 1" ID

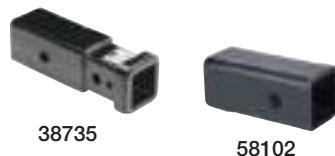

REDUCER SLEEVE



- Reduces 3" or 2-1/2" square receiver tube opening to 2"

Part No.	Description
38735	Super Titan® Reducer Sleeve, reduces 3" square receiver tube opening to 2"
58102	Titan® Reducer Sleeve, reduces 2-1/2" square receiver tube opening to 2"

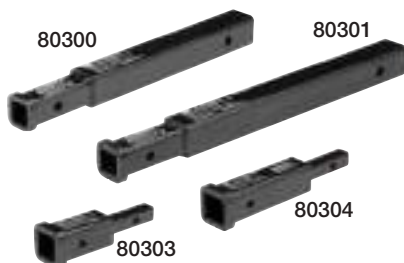

RECEIVER ADAPTERS



- Ideal for cargo carriers & bike carriers
- Designed to extend the receiver opening from 6" to 18"
- Use of this adapter reduces hitches' tow rating by 50% & with a maximum rating of 3,500 lbs towing capacity

Part No.	Description
80300	Adapts 2" to 1-1/4", 7" long, 3,500 lbs.
80301	Adapts 2" to 1-1/4", 14" long, 3,500 lbs.
80303	Adapts 1-1/4" to 2", 6" long, for Class II only; 3,500 lbs.
80304	Adapts 1-1/4" to 2", 10" long, for Class II only; 3,500 lbs.



RECEIVER EXTENSIONS



- Ideal for slide-out campers with extended overhangs
- Designed to extend the receiver opening 14", 18", 24", 34", 41" or 48"
- 2" square tube opening for use with ball mounts and hitch-mounted accessories
- Integrated electrical bracket attached (45292, 45018 only)

Part No.	Description	WC (lbs.)	WD (lbs.)	Length
80307	Receiver Extension	3,500	-	8"
80305	Receiver Extension	3,500	-	14"
80306	Receiver Extension	3,500	-	18"
11003	Receiver Extension	4,000	6,500	14"
11004	Receiver Extension	4,000	6,500	18"
11005	Receiver Extension with Step	4,000	6,500	14"
11006	Receiver Extension with Step	4,000	6,500	18"
45292	Titan® Receiver Extension (For Titan 2-1/2" receivers)	6,000 4,500	8,000 6,000	24" 34"
45018	Titan® Receiver Extension (For Titan 2-1/2" receivers)	5,000 4,000	7,500 6,000	41" 48"

WHAT'S YOUR WORKLOAD? We'll Hook You Up

PLATE MOUNTED



PINLE HOOK MOUNTING PLATE



LUNETTE RING



LUNETTE RING



DROP FORGED PINLE HITCH & BALL COMBINATION



DROP FORGED RIGID PINLE HOOK

PINLE HOOK COMBINATION



5-TON PINLE HOOK



TOW EYELET



TOW HOOK



RECEIVER MOUNTED

TOW RING



TOW HOOK



PINTLE RECEIVER HOOKS

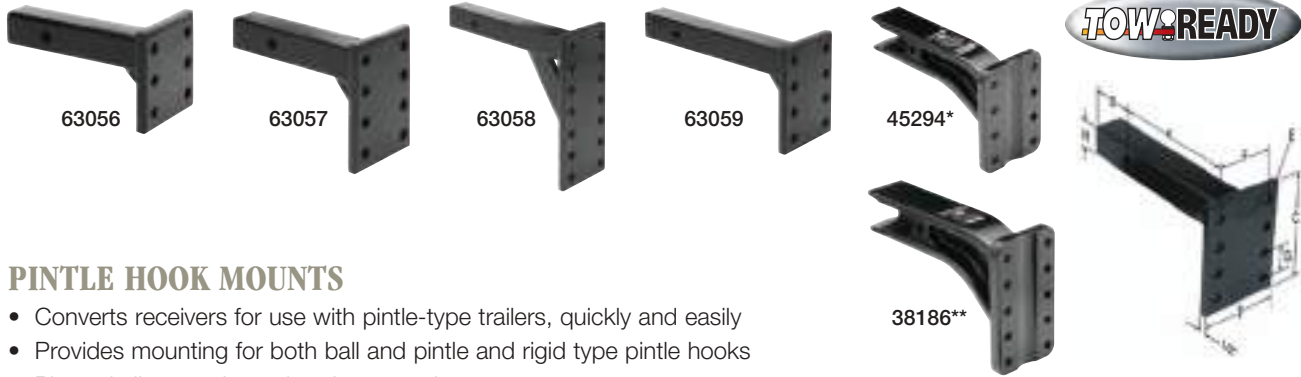

PINTLE HOOK MOUNTS

- Converts receivers for use with pintle-type trailers, quickly and easily
- Provides mounting for both ball and pintle and rigid type pintle hooks
- Pin and clip must be ordered separately

Part No.	Shank	Rating (lbs.) GTW/TW	A Shank	B Length	H Shank Dia.	C Height	D Width	E Hole	F Width	G Height	Hole Sets
63056	Hollow	6,000/600	7-5/8"	3"	2"	5-1/2"	5"	17/32"	3-3/8"	1-3/4"	3
63057	Solid	12,000/1,200	7-5/8"	3-1/4"	2"	7-1/2"	5"	17/32"	3-3/8"	1-3/4"	4
63058	Solid	8,000/800	11-3/8"	3-1/4"	2"	12-1/2"	5"	17/32"	3-3/8"	1-3/4"	7
63059	Solid	12,000/1,200	11-3/8"	3-1/4"	2"	7-1/2"	5"	17/32"	3-3/8"	1-3/4"	4
45156*	Hollow	12,000/1,200	7-3/4"	3-1/4"	2-1/2"	6"	5"	17/32"	3-3/8"	1-3/4"	3
45294*	Forged	18,000/2,000	8-1/2"	3-1/4"	2-1/2"	7-1/4"	5"	17/32"	3-3/8"	1-3/4"	4
38186**	Forged	25,000/4,000	9"	3-1/4"	3"	9"	5"	17/32"	3-3/8"	1-3/4"	5

*Titan® pintle hook adapter mount, **Super Titan® pintle hook adapter mount

PINTLE HOOKS

- Includes mounting hardware



63013
63014
63015
63016

Part No.	Description
63013	5 Ton, 2,000 lbs. max. vertical load, 10,000 lbs. GTW
63014	10 Ton, 4,000 lbs. max. vertical load, 20,000 lbs. GTW
63015	15 Ton, 6,000 lbs. max. vertical load, 30,000 lbs. GTW
63016	30 Ton, 14,000 lbs. max. vertical load, 60,000 lbs. GTW
63032	Replacement Hardware Mounting Kit

PINTLE HOOK COMBINATION HITCHES

- Includes mounting hardware
- 3,000 lbs. maximum vertical load, 16,000 lbs. maximum GTW when used as pintle hook



63010
63011
63012

Part No.	Description
63010	1-7/8" Combo Hitch, 16,000 lbs. GTW, ball rating 6,000 lbs.
63011	2" Combo Hitch, 16,000 lbs. GTW, ball rating 10,000 lbs.
63012	2-5/16" Combo Hitch, 16,000 lbs. GTW, ball rating 14,000 lbs.
63032	Replacement Hardware Mounting Kit

REPLACEMENT PARTS



63020



63032

63017
63018
63019
63050
63051
63052



Part No.	Description
63050	1-7/8" Replacement Ball, 6,000 lbs., 1-1/8" diameter
63051	2" Replacement Ball, 10,000 lbs., 1-1/8" diameter
63052	2-5/16" Replacement Ball, 14,000 lbs., 1-1/8" diameter
63020	Replacement Snapper Pin, 1/4"
43031	5/16" Safety Pin
63032	Replacement Hardware Mounting Kit
63017	1-7/8" Replacement Ball, 6,000 lbs., 1-1/4" diameter
63018	2" Replacement Ball, 10,000 lbs., 1-1/4" diameter
63019	2-5/16" Replacement Ball, 14,000 lbs., 1-1/4" diameter



LUNETTE RINGS

Part No.	Description
28023	Lunette Ring Lock (fits 2-1/2" and 3" diameter lunette rings)
4210	Lunette Ring Lock
63023	Lunette Ring, 2-1/2" diameter with 4 hole base 42,000 lbs. GTW, 8,400 lbs. maximum vertical load
63033	Hardware Mounting Kit for 63023
63022	Lunette Ring, 2-1/2" diameter with 1-1/2" shank 15,000 lbs. GTW, 2,400 lbs. maximum vertical load
63036	Adjustable Lunette Ring with Channel, 3" Dia., 24,000 lbs. Capacity
63060	Adjustable Lunette Ring with Hardware, 3" Dia., 24,000 lbs. Capacity (Adjustable Channel Sold Separately)



ONE-PIECE PINTLE HOOK

Part No.	Description	Max GTW	Ball GTW	Max VL
63043	5-Ton Receiver Mount Pintle Hook	10,000	-	2,000



ONE-PIECE PINTLE COMBINATIONS

Part No.	Description	Max GTW	Ball GTW	Max VL
63040	1-7/8" Receiver Mount Pintle Combination	12,000	2,000	2,400
63041	2" Receiver Mount Pintle Combination	12,000	7,000	2,400
63042	2-5/16" Receiver Mount Pintle Combination	12,000	12,000	2,400



RECEIVER MOUNT TOW EYELET

Part No.	Description
63045	Forged Receiver Mount Tow Eyelet, 10,000 lbs. GTW, 7-3/8" Length



RECEIVER MOUNT TOW HOOKS

Part No.	Description
63044	Forged Receiver Mount Tow Hook, 10,000 lbs. GTW, 7-3/8" Length
63047	Receiver Mount Tow Hook, 8,000 lbs. GTW, 7" Length



RECEIVER MOUNT TOW RING

Part No.	Description
63046	Receiver Mount Tow Ring, 8,000 lbs. GTW, 7-3/8" Length



CLEVIS MOUNTS

- For use with industrial/agricultural equipment

Part No.	Description	Ball Mount GTW/TW (lbs.)	Clevis Mount GTW/TW (lbs.)	Length
5761	Clevis Mount, 3/4" hole	3,500/350	5,000/350	9-3/4"
5762	Clevis Mount, 1" hole	6,000/600	6,000/600	8-7/8"
80410*	Clevis Mount, 1" hole	6,000/600	6,000/600	11"
6201	Clevis Mount, 1" hole	6,000/600	10,000/1,000	8-7/8"
5763	Clevis Pin, 3/4" dia.			4-1/4"
5764	Clevis Pin, 1" dia.			4-3/4"

* Ball Mount has 1-1/4" drop, Clevis has 3" drop



PINS AND CLIPS

Pins and clips are included with all Class I and II hitches.



Part No.	Description
63241	Packaged Class I/II Pin & Clip, 1/2", groove style
63241-050	Class I/II Pin & Clip, 1/2", groove style (50 pack)
63240	Packaged Class III/IV Pin & Clip, 5/8", groove style
63240-050	Class III/IV Pin & Clip, 5/8", groove style (50 pack)
63242	Packaged Class III/IV Pin & Clip, 5/8", hole style
63242-050	Class III/IV Pin & Clip, 5/8", hole style (50 pack)
63242-100	Class III/IV Pin & Clip, 5/8", hole style (100 pack)
63242-500	Class III/IV Pin & Clip, 5/8", hole style (500 pack)
63243	Packaged Class V Titan® Pin & Clip, 5/8", groove style
06237	Class I/II Bulk Pin, 1/2", groove style
55010	Class III/IV Bulk Pin, 5/8", groove style
55010-050	Class III/IV Bulk Pin, 5/8", groove style (50 pack)
55515	Bulk Clip
55515-050	Bulk Clip (50 pack)

SWIVEL PINS (PACKAGED)



Part No.	Description
63202	1/2" Integral Pin and Clip, stainless
63203	5/8" Integral Pin and Clip, stainless
63204	1/2" Integral Pin and Clip, zinc
63205	5/8" Integral Pin and Clip, zinc

STABILIZING PIN WITH LOCK

More than just a hitch pin, J-Pin® quickly and confidently secures ball mounts and other hitch-mounted accessories, eliminating the sway and rattle caused by part clearance issues.

J-Pin® ready receiver design allows for the most confident and secure hookup in today's towing market by compressing the hitch-mounted accessory against the inner side wall of the hitch receiver tube. Once attached, the hitch and towing components seem virtually welded together.

Packaged complete with its integral ball mount lock, J-Pin® makes your towing system complete.



63201



J-PIN®

- For 2" receivers only
- Ideal for bike racks and hitch-mounted cargo carriers
- Attachment wrench included
- Attractive point-of-purchase packaging
- Requires hitch with additional 17/32" hole in receiver tube
- Convenient 1/4" turn key for ease of use

Part No.	Description
63201	J-Pin® Anti-Rattle Pin w/Barrel Lockset



Insert J-Pin® through large hole in receiver hitch



Tighten nut on J-Pin® shaft, compressing ball mount or hitch-mounted accessory against receiver tube



Secure ball mount or hitch-mounted accessory with locking head



BULLDOG® LIFELONG® LOCKS DELIVER TRIPLE SECURITY

- Stronger Break Resistance
- Dual Self-locking Design
- High Security Square Key Design
- Includes Dust Cap



580400



580401

580402



580403

580404

LIFELONG® HITCH LOCKS WITH 5/8” DIAMETER

Part No.	Description
580400	Chrome Bent Shank Lock for Class III & IV
580401	Chrome Dogbone Lock for Class III & IV
580402	Stainless Steel Dogbone Lock for Class III & IV

LIFELONG® TRAILER LOCK

Part No.	Description
580403	Chrome Coupler Lock

LIFELONG® COMBO LOCK

Part No.	Description
580404	Chrome Combo Lock Set, 5/8" Dogbone Receiver and Coupler, for Class III & IV



580405



580406

580407

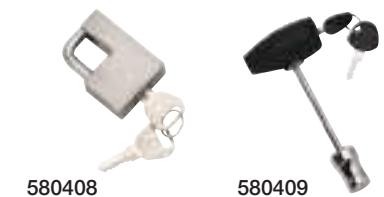

580408

580409



580410

BULLDOG® LOCKS

- Includes Dust Cap
- Easy Access Models Feature Side Key Entry, Sliding Dust Cap, Lock Housing Rotates 360°

HITCH LOCKS WITH 5/8” AND 1/2” DIAMETER

Part No.	Description
580405	Stainless Steel Dogbone Lock w/Sleeve for 1-1/4" & 2" Square Receivers
580406	Stainless Steel Combo Lock Set, 5/8" Dogbone Lock w/Sleeve for 1-1/4" & 2" Square Receivers and Coupler
580407	Easy Access Lock w/Sleeve for 1-1/4" & 2" Square Receivers

TRAILER LOCKS

Part No.	Description
580408	Stainless Steel Coupler Lock
580409	Easy Access Long Coupler Lock
580410	Easy Access Adjustable Coupler Lock
TK100 0100	Trailer Keeper® Lock - Heavy-duty, hardened steel construction. Adjustable to fit most trailer wheels up to 15". Includes brass lock and key set.



TK100 0100



63234

HITCH LOCKS WITH 5/8" AND 1/2" DIAMETER

Part No.	Description
63234*	Dogbone Lock w/Sleeve for 1-1/4", 2" & 2-1/2" Square Receivers
63248	Bent Pin Lock w/Extra Pin for 1-1/4" & 2" Square Receivers

* not compatible with 18K Titan® Receivers



63224

HITCH LOCKS WITH 1/2" DIAMETER

Part No.	Description
63224	Bent Pin Lock for 1-1/4" Square Receivers



63223

HITCH LOCKS WITH 5/8" DIAMETER

Part No.	Description
63223	Bent Pin Lock for 2" & 2-1/2" Square Receivers
63252	Dogbone Lock for 2-1/2" Square Receivers, 3-1/2" Span, Class V
63253	Bent Pin Lock for 2-1/2" Square Receivers, 3-1/2" Span, Class V

63252



63225

63230



63226

63227

TRAILER LOCKS

Part No.	Description
63225	Coupler Lock
63230	Brass Coupler Lock
63226	Universal Coupler Lock
63227	Coupler Lock for 2-5/16" Ball
63228	Coupler Lock for 2" Ball



63228

COMBO LOCKS (HITCH, 5/8" & 1/2" DIA., AND TRAILER)



63249

63250

Part No.	Description
63249	Combo Lock Set, Bent Pin/Brass Coupler, for 1-1/4" & 2" Square Receivers
63250	Combo Lock Set, Dogbone Receiver/Coupler, for 1-1/4" & 2" Square Receivers



63232

SILENT HITCH PIN AND LOCK SYSTEM

Eliminates noise associated with hitch accessories rattling against receiver tube. Unique design holds drawtube tight inside hitch receiver tube. For use with hollow shank ball mounts only.



63145-025

Part No.	Description
63232	Class III Silent Hitch Pin, 5/8" design for 2" Square Receivers w/lock and wrench
63232-025	Class III Silent Hitch Pin, 5/8" design (25 pack)
63146	Silent Hitch Pin w/Handle and Clip, 5/8" for 2" Square Receivers
63145-025	Silent Hitch Pin w/Clip, 5/8" for 2" Square Receivers (25-pack)



KEYED ALIKE COUPLER AND HITCH LOCKS

- Avoid the complication of having to keep track of different keys for every lock
- Includes 2 keys
- Order in multiples of 3 / minimum order is 3 locks (TP20A1534 minimum is 21 locks)

Part No.	Description
63216KA	KEYED ALIKE 1/2" Receiver Lock for Class II Receiver Hitches
63217KA	KEYED ALIKE 5/8" Receiver Lock for Class III & IV Receiver Hitches
63218KA	KEYED ALIKE Class II 1/2" Receiver Lock and 1/2" Span Style Coupler Lock
63219KA	KEYED ALIKE Class III & IV 5/8" Receiver Lock and 1/2" Span Style Coupler Lock
63220KA	KEYED ALIKE 1/2" Span Style Coupler Lock
63221KA	KEYED ALIKE 2" Span Style Coupler Lock with 1/4" Pin
63222KA	KEYED ALIKE 2-1/2" Span Style Coupler Lock with 1/4" Pin
TP20A1534	KEYED ALIKE 2" Coupler Lock



TRAILER GUARDIAN LOCKS

- Helps prevent accidental decoupling
- Ability to lock and secure the trailer on the tow vehicle
- Two piece construction



Part No.	Description
63235	Single Arm Lock for 2-1/2" Wide Ball Mnt. Platform w/1" Ball Hole
63236	Dual Arm Lock for 2-1/2" Wide Ball Mnt. Platform w/1" Ball Hole
63237	Single Arm Lock for 3" Wide Ball Mnt. Platform w/1" Ball Hole
63238	Dual Arm Lock for 3" Wide Ball Mnt. Platform w/1" Ball Hole

Note: Cannot be used with some ball mounts in the rise position.



CHROME RECEIVER TUBE COVERS

Part No.	Description
5351	Receiver Tube Cover, 1-1/4" Sq., Chrome, Metal
5352	Receiver Tube Cover, 2" Sq., Chrome, Metal
80961	Receiver Tube Cover, 2" Sq., Chrome, Plastic
1944	Receiver Tube Cover, 2" Sq., Chrome, Plastic



RECEIVER TUBE COVERS

Part No.	Description
58070	Receiver Tube Cover, 1-1/4" Sq., Black, Nylon (24 pack)
1202	Receiver Tube Cover, 2" Sq., Black
01202-024	Receiver Tube Cover, 2" Sq., Black (24 pack)
5363	Receiver Tube Cover, 2" Sq., Black, Plastic (1202 with Header Card)



RUBBER RECEIVER TUBE COVERS W/"D" LOGO

Part No.	Description
5362	Rubber Receiver Tube Cover, 1-1/4" Sq. w/"D" logo with Header Card
2211	Rubber Receiver Tube Cover, 1-1/4" Sq. w/"D" logo (bulk)
7050	Rubber Receiver Tube Cover, 2" Sq. w/"D" logo with Header Card
7010	Rubber Receiver Tube Cover, 2" Sq. w/"D" logo (bulk)
07010-024	Rubber Receiver Tube Cover, 2" Sq. w/"D" logo (24-pack)



RUBBER RECEIVER TUBE COVERS W/"HIDDEN HITCH" LOGO

Part No.	Description
60037	Class I/II Cover, rubber 1-1/4" Sq. with Header Card
60037-024	Class I/II Cover, rubber 1-1/4" Sq. (24 pack)
80037	Class III Cover, rubber 2" Sq. with Header Card
80037-012	Class III Cover, rubber 2" Sq. (12 pack)

"HITCH HIDER" RUBBER TUBE COVER

- Securely attaches to any 2" receiver tube
- Rubber construction tightly seals tube opening
- Built-in 4-way flat electrical cover



Part No.	Description
5330	Class III Cover, black rubber
05330-010	Class III Cover, black rubber (10 pack)



80953

PLASTIC COVERS

- Provides custom finish
- Impact resistant construction



Part No.	Description
80953	Class III Cover, plastic



6431



6432

LOGO RECEIVER TUBE COVERS

- Attractive point-of-purchase packaging
- Foam gasket included for exact fit
- Heavy chrome face features popular OEM manufacturer logos
- OEM licensed

6433



Part No.	Description
6431	Chevrolet logo, fits all 2" receivers
6432	Dodge Ram logo, fits all 2" receivers
6433	Ford oval logo, fits all 2" receivers

74099



74547



45144

RECEIVER TUBE COVERS W/"REESE" LOGO

- Attractive point-of-purchase packaging
- Foam gasket included for exact fit
- Heavy chrome face features popular OEM manufacturer logos
- OEM licensed

Part No.	Description
74099	Receiver Tube Cover, 2" Sq., w/"Reese" logo
74547	Receiver Tube Cover, 2" Sq., w/"Reese" logo
45144	Titan® Receiver Tube Cover, 2-1/2" Sq., W/"Reese" logo

80980



BRAKE LIGHT COVER

This handy cover doubles as an additional brake light. It plugs into a 4-way flat connector and lights up with turn and brake functions.

Part No.	Description
80980	Brake Light Cover, Class III

42250-012



42250



HITCH BALL COVER



Part No.	Description
42250	Hitch Ball Cover 1-7/8" - 2"
42250-012	Hitch Ball Cover Display Pack 1-7/8" - 2" (12 pack)
42251	Hitch Ball Cover 2-5/16"
42251-012	Hitch Ball Cover Display Pack 2-5/16" (12 pack)